



User`s Manual .of Industrial Chiller - Cutting Chiller

WUHAN HANLI REFRIGERATION TECHNOLOGY CO., LTD.

Add: No. 1, Second Road,XingFuYuan, Hannan District, Wuhan, China

Post Code: 430090 Email: hanli@hanli-wh.com

Tel: +86-15871786637 +86-13554229733

Service Hotline : 400-855-6775

WeChat service platform



www.hanlizl.com

Thank you very much for using the cooling equipment of Wuhan Hanli Refrigeration Technology Co., Ltd.

Preface

Thank you for your trust in our company and choosing to use our company's fiber laser chillers . In order to enable you to better understand and use our company's products to achieve the best results , we will provide you with complete after-sales service . Please contact us at Read this manual carefully before use , and consult this manual if you have any questions while using the product.





This manual is prepared for the owners and users of the chiller . It includes the product's performance parameters , appearance and component names , working principle , daily maintenance , fault description and troubleshooting methods, etc. , and is used for installation, operation, debugging and repair.







This manual is not a quality guarantee . Printing errata , modifications to product information , and product improvements are subject to final interpretation by our company without prior notice. The updated content will be included in the reprinted manual. If you have any questions or suggestions for improvement regarding the use of the product , please contact our company's service personnel.







Table of contents



Preface.....	2
Warning.....	1
1. Overview.....	6
2 Conditions of use.....	7
3 Model description.....	9
4 performance parameters.....	10
5 Appearance and component names.....	12
6 installation.....	12
6.1 Installation conditions and requirements.....	12
6.2 Waterway connection.....	13
6.3 Precautions for circuit connection.....	14
6.4 Adding water and exhausting air.....	14
6.5 Warm reminder.....	15
7 Product use.....	15
7.1 Inspection before test.....	15
7.2 Introduction to controller panel.....	15
7.3 Power on display.....	19
7.4 Temperature display.....	19
7.5 Parameter settings.....	20
8 Maintenance.....	23
8.1 Dust protection in summer.....	23
8.2 Antifreeze in winter.....	24
8.3 Daily maintenance.....	25
9 Fault analysis and troubleshooting.....	27
10 Circuit diagram.....	31
11 Transportation and storage.....	31
11.1 Transportation requirements.....	32
11.2 Storage requirements.....	32
12 Other instructions.....	33
12.1 Service support.....	33
12.2 Other matters.....	33







Warning



 DANGER Be sure to take safety measures , otherwise death or serious personal injury may result.		
Prompt items	reminder sign	operating instructions
Please have it operated by technicians with professional knowledge	 Must Be Perfermed	Transportation, installation of piping, electrical, operation, maintenance, inspection and other operations must be carried out by personnel with professional knowledge.
High voltage hazard		Contact with live parts can cause serious personal injury or death.
High temperature burns		Any part of the body and heat-intolerant items must be kept away from this high temperature area , otherwise personal injury or property damage may occur.
Electrical connections	 Must Be Perfermed	a) The power supply system must be selected according to the relevant contents on the nameplate or instructions; b) The cable must use standard cable , and the wire diameter is selected according to the standard; c) Grounding must be installed to ensure reliable connection , otherwise it may cause the risk of electric shock or fire.

	DANGER Be sure to take safety measures , otherwise death or serious personal injury may result.	
Prompt items	reminder sign	operating instructions
Maintenance and repair	 Must Be Performed	Work must be carried out after cutting off the power for 3 minutes.
scrapped	 Must Be Performed	When the equipment reaches the end of its service life and needs to be scrapped , it must be disposed of as industrial waste and please ask professionals for guidance on scrapping.
It is prohibited to use it beyond the specification range.	 Forbid	to use the equipment beyond the specifications in the manual to avoid equipment damage, injury, fire, electric shock and other major accidents.
Cannot be used in explosive environments	 Forbid	It cannot be installed in dangerous places with flammable gases .
The equipment is prohibited from operating without a cover.	 Forbid	There are live parts inside the machine . It is prohibited to operate without an outer cover . There is a risk of electric shock.
water proof	 Forbid	Do not let the equipment be exposed to water or soaked in water , otherwise there may be a risk of short circuit and electric shock.

 Warning Be sure to take safety measures , otherwise death or serious personal injury may result.		
Prompt items	reminder sign	operating instructions
Transportation and installation	 Must Be Performed	When transporting and installing the equipment , the equipment must be firmly fixed , otherwise there is a risk of overturning or falling.
electrical protection	 Must Be Performed	The power cable entry end must match the leakage and overload protection device according to the rated current indicated on the equipment nameplate.
Immediately stop operation when an abnormality occurs	 Must Be Performed	When an abnormality occurs in the equipment , it is prohibited to start as long as the cause is not clear . Otherwise , there is a risk of damage, electric shock, fire, or injury.
Never reach into gaps in equipment	 Forbid	There are rotating parts installed in the equipment . It is prohibited to put fingers or foreign objects into the gaps of the equipment when the equipment is running , otherwise it may cause personal injury.
Refrigerant leakage	 Must Be Performed	a) When a refrigerant leak occurs , be sure to ventilate the air . Otherwise , when a large amount of refrigerant fills the enclosed space , it may cause anesthesia and suffocation to the human body; b) Avoid contact with skin , otherwise frostbite may occur.

 Please take safety measures , otherwise minor personal injury and property damage may occur.		
Prompt items	reminder sign	operating instructions
Liquid transportation is prohibited	 Forbid	It is forbidden to transport the equipment with liquids to prevent leakage of internal pipelines .

Usage environment	 Forbid	<p>a) It is prohibited to use in special environments such as high temperature, humidity, strong electromagnetic interference, etc.;</p> <p>b) The equipment must be installed in a place away from direct sunlight and away from fire sources.</p>
Install	 Must Be Performed	<p>a) The equipment must be installed horizontally , otherwise the refrigeration system will fail;</p> <p>b) It is prohibited to place objects within 1.5 meters around the air suction outlet and within 2.0 meters around the air exhaust outlet. If the suction and exhaust air is obstructed , the cooling capacity that the equipment should have cannot be exerted.</p>
Before commissioning	 Must Be Performed	<p>a) Make sure that the water supply pipe on the equipment side is not blocked;</p> <p>b) It is necessary to check the water pipe and water pump to confirm that an appropriate amount of water has entered the water pump and exhaust it through the water pump exhaust valve , otherwise the water pump will be damaged;</p> <p>c) Confirm that the equipment is in normal and safe condition , otherwise there may be injury and damage.</p>
It is prohibited to step on the equipment	 Forbid	<p>Please do not get on the equipment or sit on it , otherwise it may cause injuries from falling or overturning.</p>
the air filter regularly	 Must Be Performed	<p>Clean the air filter at least once a week . If the air filter is clogged , the cooling capacity will be reduced , power consumption will increase , and the alarm may not work properly.</p>
Equipment surface cleaning	 Must Be Performed	<p>a) Please use cleaning agents that are non-corrosive to metals and plastics;</p> <p>b) Please keep the cleaning agent properly after cleaning to prevent liquid from leaking anywhere on the equipment;</p> <p>c) The container storing the cleaning agent must be completely sealed to avoid danger.</p>

<p>Protective gloves should be worn during maintenance, inspection and cleaning</p>	 Must Be Performed	<p>a) The sharp edges of the condenser fins may cause skin cuts;</p> <p>b) The temperature of the internal compressor and refrigerant piping is very high , and direct contact with the skin may cause burns.</p>
<p>Antifreeze</p>	 Must Be Performed	<p>When the ambient temperature is below 0°C and the machine is shut down for a long time , the liquid needs to be drained and the water in the system must be blown clean with compressed air . Otherwise, there is a risk of frozen components and pipelines.</p>

To ensure your personal safety and avoid property damage , you must pay attention to the warnings in our instructions. Warning tips are listed above in descending order of risk level , but are not limited to the above list . General common sense and safety regulations for electricity use should also be followed.

1. Overview

This product is a cooling device designed and manufactured for laser cutting, laser welding, laser engraving, laser marking, laser printing and other equipment that uses laser processing. It can provide two channels of temperature-stable refrigerant for the above application scenarios , one is the low-temperature coolant to cool down the fiber laser , and the other is normal-temperature coolant to cool down the fiber laser cutting head.

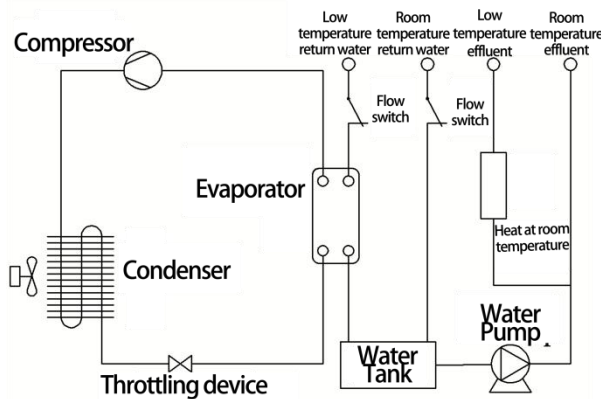

Figure 1-1 Chiller system composition and working principle

The chiller is composed of a compressor, a condenser, a throttling device, an evaporator, a water tank and a water pump . Its working principle is that the compressor compresses the superheated steam sucked from the

evaporator into high-temperature and high-pressure gas , and discharges it to the condenser. The evaporator condenses and releases heat into high-pressure liquid , which is decompressed by the throttling device and becomes a low-temperature and low-pressure subcooled liquid. The low-temperature and low-pressure subcooled liquid vaporizes and absorbs heat through the evaporator to become superheated steam , and then returns to the compressor again to enter the next cycle to achieve refrigeration function. The heat absorbed by the vaporization of the refrigerant in the evaporator comes from the secondary refrigerant . The temperature of the secondary refrigerant will decrease , and it will be divided into two parts by the water pump and pressed out. One way will cool down the laser , and the other part will be heated by the heating device into normal temperature coolant to cool the fiber laser head.

2 Conditions of use

2.1 Environmental requirements

Ambient temperature: $-20 \sim 45^{\circ}\text{C}$;

Relative humidity: $\leq 90\%$;

Altitude: $\leq 3000\text{m}$;

the refrigerant temperature and the ambient temperature is shown in Figure 2-1 :

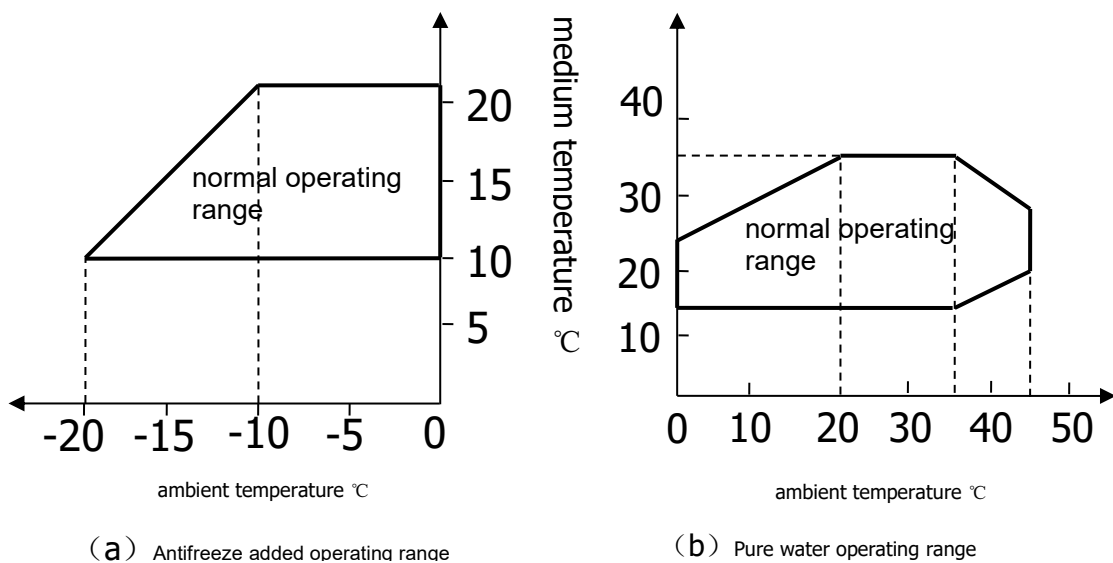

Figure 2-1 Equipment operating range

Note : The above operating range is obtained in the laboratory based on standard product testing for reference . The operating range of each specific model of product may be slightly different . Please contact the manufacturer for details.

2.2 Refrigerant requirements

2.2.1 Water quality requirements and risk warnings

The secondary refrigerant must be purified water.

Recommended water quality parameters: pH 7.0~7.6, conductivity 10-500 μ S/cm, chloride concentration less than 10mg/L.

If it is not used as required, tap water or non-pure water is filled, the following risks will occur:

1. Tap water or impure water will form scale after high temperature heating, and the scale will affect the internal purity of the laser head and cause the laser head to burn out.
2. Microorganisms will breed in the water tank, which will attach to the plate changer and laser through the water circulation, affecting the heat exchange effect. As the microorganisms continue to multiply, it will cause plate replacement and laser blockage, resulting in laser high temperature alarm.
3. If the tap water is acidic or alkaline, it may corrode the cold plate of the laser, and the solid oxides generated by the reaction will seriously block the internal channel of the plate, resulting in high system pressure and even water leakage.

2.2.2 Antifreeze requirements

It is allowed to add a volume ratio of $\leq 30\%$ ethylene glycol or a volume ratio of $\leq 20\%$ ethanol . It is allowed to add preservatives and bactericides approved by the manufacturer.

It is strictly prohibited to use antifreeze with a volume ratio of $>30\%$, it is strictly prohibited to use oil and oil-based liquids , it is strictly prohibited to use flammable and explosive liquids , it is strictly prohibited to use liquids with solid particles , especially liquids that are corrosive to aluminum and stainless steel.

3 Model description

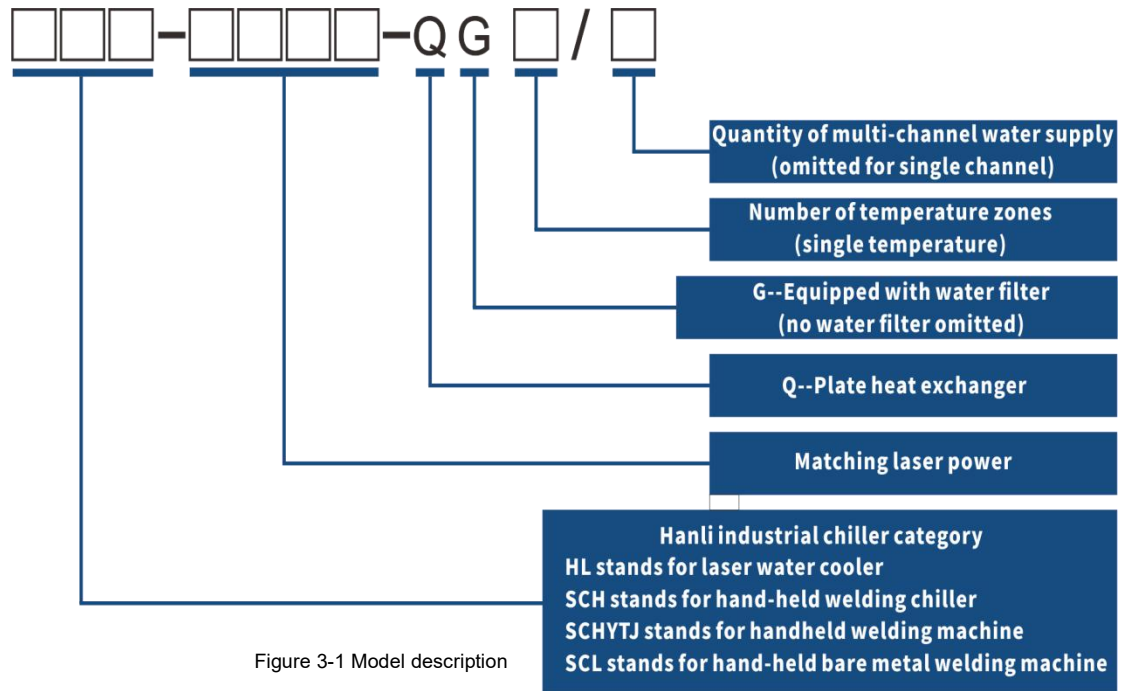

Figure 3-1 Model description

For example:

model	significance
HL-3000-QG2/2	air-cooled laser cutting machine with laser power of 3000W , dual temperature and two-way water supply.
HL-3000-QGS	water-cooled laser cutting machine with laser power of 3000W , dual temperature and two-way water supply.

4 performance parameters

SN	Device model	power supply	power /kW	refrigerant	Filling capacity / kg	Lift / m	flow / m³/h	Weight / kg	Equipment size / mm	water volume / L
1	HL-1000-QG2/2	220V 50Hz	2.3	R32	0.23	33	1.6	32	515×430×725	15
2	HL-1500-QG2/2	220V 50Hz	2.3	R32	0.23	33	1.6	32	515×430×725	15
3	HL-2000-QG2/2	220V 50Hz	2.8	R32	0.24	33	1.6	32	515×430×725	15
4	HL-3000-QG2/2	220V 50Hz	3.6	R32	0.35	45	3	48	565×500×815	28
5	HL-4000-QG2/2	380V 50Hz	4.5	R32	0.48	40	3.6	70	610×660×1000	55
6	HL-6000-QG2/2	220V 50Hz	6.2	R32	0.33×2	40	3.6	85	1040×510×890	55
7	HL-8000-QG2/2	380V 50Hz	9.7	R32	0.789	46	5	117	815×710×1065	77
8	HL-12000-QG2/2	380V 50Hz	15.2	R32	1.1	54	8	145	780×760×1060	77
9	HL-15000-QG2/2	380V 50Hz	20	R32	1.55	55	10	208	1590×750×1010	160
10	HL-20000-QG2/2	380V 50Hz	20	R32	1.55	55	10	208	1590×750×1010	160
11	HL-30000-QG2/2	380V 50Hz	30	R32	1.7	58	16	290	1835×840×1130	240
12	HL-40000-QG2/2	380V 50Hz	40	R32	1.9*2	50	25	461	1670×1515×1295	360
13	HL-50000-QG2/2	380V 50Hz	55.5	R32	3.1*2	55	40	764	2300×1450×1520	450
14	HL-60000-QG2/2	380V 50Hz	55.5	R32	3.1*2	55	40	761	2300×1450×1520	450

Below 60 Hz										
SN	Device model	power supply	power /kW	refrigerant	Filling capacity / kg	Lift / m	flow / m³/h	Weight / kg	Equipment size / mm	water volume / L
29	HL-1500-E-QG2/2	220V 60Hz	2.3	R32	0.24	33	1.6	32	515×430×725	15
30	HL-3000-E-QG2/2	220V 60Hz	4	R32	0.33	45	3	48	565×500×815	28
31	HL-6000-E-QG2/2	2200 V 60Hz	7.3	R32	0.33×2	40	3.6	96	1100×570×960	55
32	HL-12000-E-QG2/2	380V 60Hz	15.2	R32	1	54	8	145	780×760×1060	77
33	HL-20000-E-QG2/2	380V 60Hz	20	R32	1.6	57	12	208	1590×750×1010	160
34	HL-30000-E-QG2/2	380V 60Hz	30	R32	1.7	53	20	290	1835×840×1130	240
35	HL-40000-E-QG2/2	380V 60Hz	46	R32	2.7×2	62	25	624	1740×1400×1445	360

Note : The above table is some standard product performance parameters , for reference only , and is subject to change without prior notice.

5 Appearance and component names

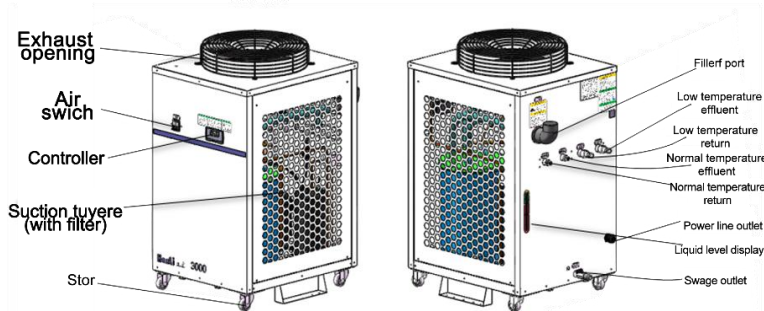

Figure 5-1 Appearance and component

Note : The appearance and component names mentioned on the left are just one of the models . The appearance and

component names of different models will be slightly different .

6 installation

6.1 Installation conditions and requirements

- Open the package and first check whether the equipment is in good condition and whether the accessories list is complete.
- It must be installed horizontally and cannot be tilted , as shown in Figure 6-1.

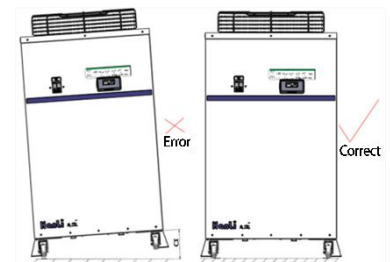

Figure 6-1 Requirements for

Equipment without casters needs to be fixed with anchor bolts , and equipment with casters must lock the universal wheels.

- There must be no obstructions within 1.5m of the air inlet and 2.0m of the air exhaust to avoid affecting the heat dissipation of the equipment , as shown in Figure 6-2.
- The product must not be installed in harsh environments such as corrosive and flammable gases, heavy dust, oil mist, metal and other conductive dust, high temperature and humidity, strong magnetic fields, direct sunlight, etc. , as shown in Figure 6-3 .

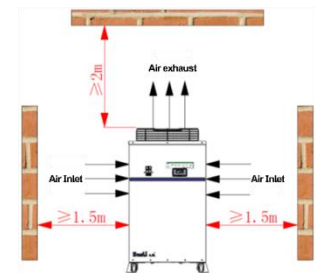

Figure 6-2 Equipment

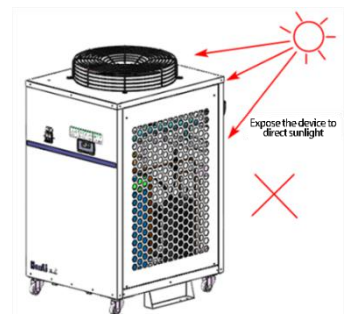

Figure 6-3 Equipment

6.2 Waterway connection

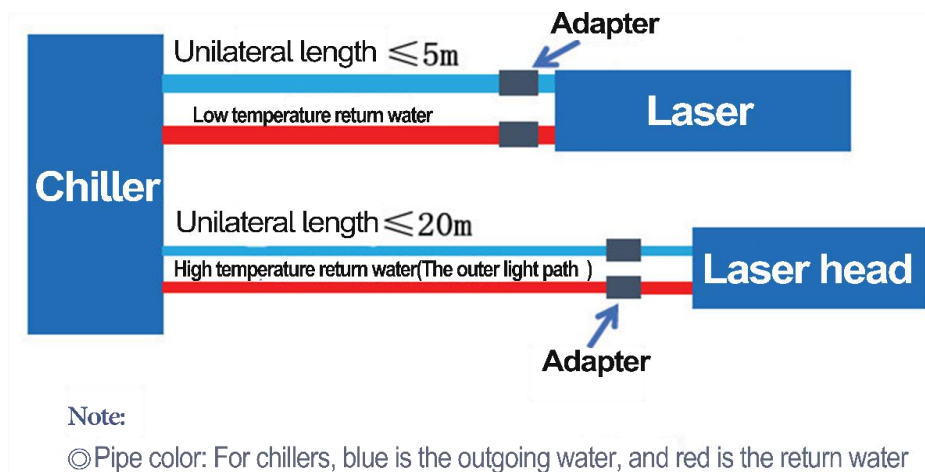

Figure 6-4 Connection diagram between chiller and laser

Precautions for water connection

- To ensure the normal operation of the equipment, the pipeline layout direction needs to be determined according to the equipment inlet and outlet markings.
- When constructing inside the pipeline, be sure to clean it thoroughly and strictly prevent impurities from entering the system. The presence of impurities in the system may reduce the cooling capacity and may cause failure of the water pump or refrigeration system.
- Use opaque pipes as pipeline materials to prevent microorganisms from growing and contaminating water quality.
- The joints and ball valves connected to the pipelines should be made of stainless steel to prevent ionization corrosion of water-soluble substances and the formation of sediments and other impurities, which can block the plate changer, water pump or cold plate.
- When connecting the chiller to the laser, follow the method in Figure 6-4, and the inner diameter of the pipe must not be smaller than the diameter of the inlet and outlet of the chiller. If the inner diameter of the piping is smaller than the requirements, the consent of the chiller manufacturer must be obtained.
- When connecting pipelines between equipment, the distance should be kept to the shortest and right angles and bends should be avoided to ensure that the total pressure drop does not exceed 0.05MPa.
- If metal piping is used, insulation measures must be taken to prevent energy loss.
- Ensure that the pipeline pressure is more than 1.5 times the water supply pressure of the water pump.
- HL-3000/4000/6000/8000/12000/15000/20000/30000/40000/50000/60000/80000/100000 is equipped with a filter, please clean it regularly.

6.3 Precautions for circuit connection

1. Please refer to the wiring identification of the chiller when wiring.
2. Recommended reference standards for power supply wire diameter selection.

Rated current / A	2.5-4	5-8	9-13	14-20	21-25	26-32	33-45	46-63	64-85	86-101
Power wire diameter (copper wire)/mm ²	0.5	1.0	1.5	2.5	4.0	6.0	10.0	16.0	25.0	35.0

- This data is provided in accordance with the IEC 60204-1 standard and is for reference only.
- The power cord must use a standard cable.
- See the chiller nameplate for rated power.
- Ensure that the ambient temperature range is -20°C-45°C, and the maximum temperature of the wire ≤70° C.

3. The main circuit of the power supply must be equipped with appropriate leakage and overload protection devices , and ensure that the chiller is well grounded.

4. The power supply voltage is allowed to fluctuate less than ±10% , the frequency fluctuation is less than ±1Hz , and it should be kept away from electromagnetic interference sources.

5. Signal terminal connection: The output is a passive dry node signal for flow alarm and over-temperature alarm.

6.4 Adding water and exhausting air

6.4.1 add water

Add purified water through the water inlet of the equipment to the liquid level standard area (green area) , as shown in Figure 6-5.

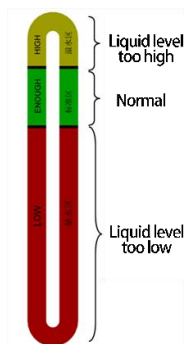

Figure 6-5 Liquid Level Identification

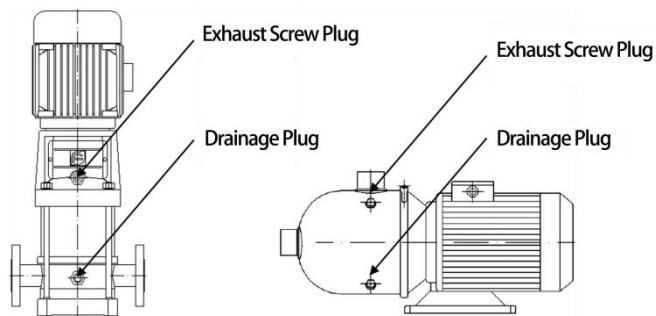

Figure 6-6 Water pump exhaust and drainage

6.4.2 Venting and draining

After adding water and replacing new water for the first time , be sure to drain the air from the water pump before starting it , otherwise the equipment will be damaged. To exhaust the air , slowly loosen the exhaust screw plug of the water pump (do not unscrew it) until air is discharged until water flows out , then tighten the exhaust screw plug (see Figure 6-6 , only the vertical version is shown in the figure) The exhaust position of the pump and horizontal pump is indicated. The pump will be different according to the customer's requirements and the specific model , and the exhaust position will also be different . For details, see the external prompt mark of the water pump). Note: When the liquid in the equipment needs to be drained in winter , loosen the drainage plug below to drain the liquid.

6.5 Warm reminder

After the equipment is powered on and the water pump is running for a period of time , continue to add water to the water tank to the standard liquid level area.

7 Product use

7.1 Inspection before test

- Check whether the inlet and outlet water ball valves are open and whether the drain valve is closed;
- Check whether the waterway connection is correct , whether it is loose , and there should be no bubbling or leaking;
- Check whether the water tank liquid level is in the standard area;
- Check whether the power supply type matches the product nameplate . The 380V power cord is generally a three-phase five-wire system , and the 220V power cord is a single-phase three-wire system;
- Check whether the equipment is grounded;
- Check that the electrical wiring between equipment is connected correctly.

7.2 Introduction to controller panel

Currently, there are three types of controllers for Hanli fiber laser chillers, as shown below.

7.2.1 Introduction to Hanli split controller panel

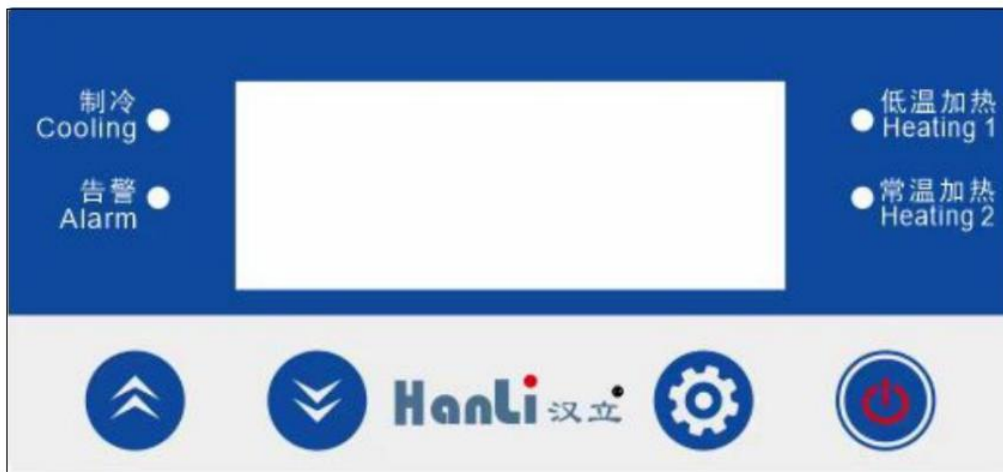

Figure 7-1: Hanli Split Controller Panel

Digital Tube	use		
display window	Displays the measured temperature of low-temperature water (L.xx.x/normal temperature water H.xx.x), set temperature display (low-temperature water S.xx.x/normal temperature water temperature difference d.xx.x), alarm code (Exx), Parameter code (Fxx 0) .		
indicator light	use		
Cooling	Lights up: compressor is working	Off: compressor shuts down	Flashing: cooling required
Low temperature heating (Heating1)	Light up: low temperature water heating work	Off: Low temperature water heating is turned off	
Heating at room temperature (Heating2)	Light up: normal temperature water heating work	Off: Normal temperature water heating is turned off	
Alarm	Flashing: There is a fault	Off: No fault	
button	use		
On/Off key	Press <On/Off> key for 3 seconds to turn on or off		
Set key	Under non-fault conditions , press the <Set> key to enter/exit the set temperature.		
Up/Down keys (▲ ▼)	During the parameter setting process , modify the parameter value.		

7.2. 2 LCD controller panel introduction



Figure 7-2 LCD screen controller panel

Number management code	use		
Real-time temperature (PV)	Displays "actually measured water temperature and alarm code".		
Set temperature (SV)	"Set temperature" is displayed.		
indicator light	use		
Compressor	Lights up: compressor is on	Off: compressor shuts down	Flashing: There is a need for refrigeration but the press has not been started yet
Pump	Lit: pump on	Off: pump is off	
Heat	Lights up: Heating is on	Off: heating off	
Switching to the low-temperature water interface indicates low-temperature water heating, switching to the normal-temperature water interface indicates normal-temperature water heating.			
Solenoid valve (Valve)	doesn't work		
Remote	Lights up : The remote switch is closed.	Off: remote switch is disconnected	
Run	Lights up: The unit is working	Off: unit shuts down	Flashing: The unit is in antifreeze mode
Fault indication (Alarm)	Flashing: There is a fault	Off: unit shuts down	
button	use		
On/Off key	Press the <On/Off> key for 3 seconds to power on or off.		
Set key	Under non-fault conditions , press the <Set> key to enter/exit the set temperature.		
Up/Down keys (▲ ▼)	During the parameter setting process , modify the parameter value.		

7.2.3 Introduction to the All-in-One Controller Panel

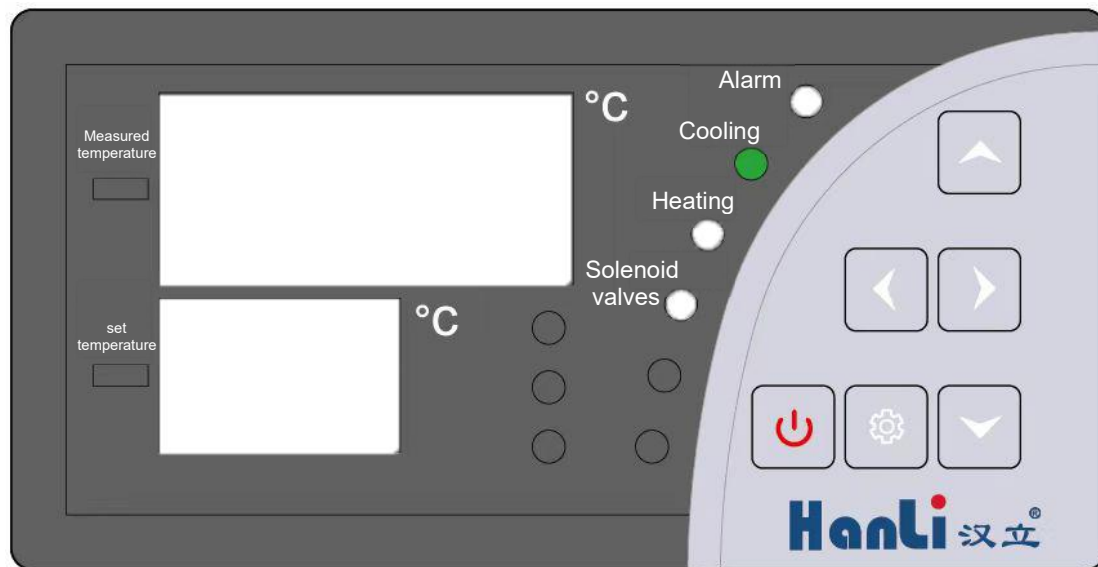





Figure 7-3 All-in-One Controller Panel

Digital Tube	use		
display window	Displays the measured temperature of low-temperature water (L.xx.x/normal temperature water H.xx.x), set temperature display (low-temperature water S.xx.x/normal temperature water temperature difference d.xx.x), alarm code (Exx), Parameter code (Fxx 0) .		
indicator light	use		
Cooling	Lights up: compressor is working	Off: compressor shuts down	Flashing: cooling required
Heating	Light up: low temperature water heating work	Off: Low temperature water heating is turned off	
Solenoid valves	Light up: normal temperature water heating work	Off: Normal temperature water heating is turned off	
Alarm	Flashing: There is a fault	Off: No fault	
button	use		
On/Off key	Press <On/Off> key for 3 seconds to turn on or off		
Set key	Under non-fault conditions , press the <Set> key to enter/exit the set temperature.		
Up/Down keys (▲ ▼)	During the parameter setting process , modify the parameter value.		
Left/Right keys (◀ ▶)	During the parameter setting process , modify the parameter value.		

7.3 Power on display

After the split controller device is powered on , the display window displays the software version information (Fxx/v100/A00) , and enters the temperature display state after about 7 seconds.

the LCD controller is in the main interface, press for  3 seconds to turn it on. After turning it on, the status bar of the main interface will display "Running";  press it again for 3 seconds to turn it off. After shutting down, the main interface will display "Stop"

When the all-in-one controller is not in the setting state, long press and hold  to turn off the power, the main display will show off and enter the standby state. In standby mode, long press and hold  to enter the startup phase..

7.4 Temperature display

Split controller temperature display



The display window displays low-temperature water measurement water temperature (L.xx.x) by default. When the temperature is displayed , press the <▼> key to switch the display between the measured water temperature of normal temperature water (H.xx.x), the set water temperature of low-temperature water (S.xx.x), and the set temperature difference of normal temperature water (d.xx.x). , it will automatically return to the low-temperature water interface without switching operation for 30 seconds.

[Remarks]: L./H./S./d. is the temperature code , xx.x is the temperature value .

LCD controller temperature display

The PV area displays "actual temperature" and the SV area displays "set temperature".



All-in-on controller temperature display

After startup, under non-setting state, the main screen displays the real-time temperature, the secondary screen displays the setting temperature, and the real-time LED/setting LED is on to indicate that the current display is the ambient water temperature, and the ambient water setting temperature. In non-setting state, shortly press  or  to switch the real-time temperature of low-temperature water and its setting temperature / real-time temperature of room-temperature water and its setting temperature / alarm (In the single temperature range, only the cold water temperature is displayed.if there is an alarm, it will be displayed).



7.5 Parameter settings





7.5.1 Split controller parameter settings



In the non-fault state , press the key  to enter the low-temperature water set temperature setting interface . The set temperature " S.xx.x " flashes on the display

. At this time, the set temperature can be modified by pressing the  or  key. After the setting is completed, if you press the button briefly  or do not press the button for 5 seconds , the system will save the set value and exit the setting state.

Normal water set temperature = [Low temperature water set temperature] + [F01 normal temperature water temperature difference] ,
Changes require modifying *the manufacturer's parameter settings* [F01 normal temperature water temperature difference].

Enter the manufacturer's parameter setting : On the temperature display interface , press the  +  button at the same time for 5 seconds to enter the manufacturer's parameter setting state . The factory-set parameters are generally not adjusted . If adjustments are needed , please seek consent from the chiller manufacturer.

Select manufacturer parameters : During the process of selecting manufacturer parameters , press  the or  key to select parameter items , short  press the key to enter parameter settings , and exit the manufacturer parameter settings after no button operation for 15 seconds or short press the key again (the display window displays parameter items). 

Parameter setting: When setting parameters , you can  modify the parameter value by pressing the or key  . After 5s without pressing the key or pressing the key, return to parameter selection and save (the display window flashes to display the parameter value). 

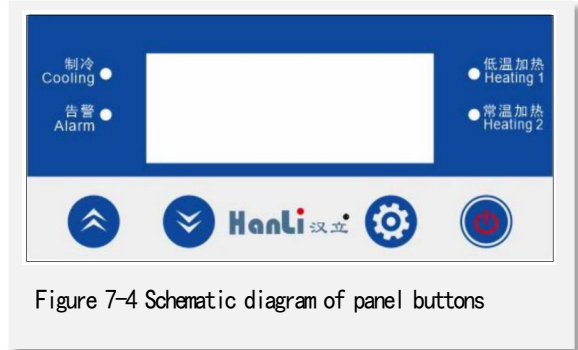

Figure 7-4 Schematic diagram of panel buttons

7.5.2 LCD screen controller parameter settings

①. Quickly modify the set temperature

If the user parameter [Lock Temperature] is set to "No", the set temperature can be modified directly in the main interface, as shown in the figure :

[Note 1] :

You can also modify it in the user parameters. Change the set temperature .

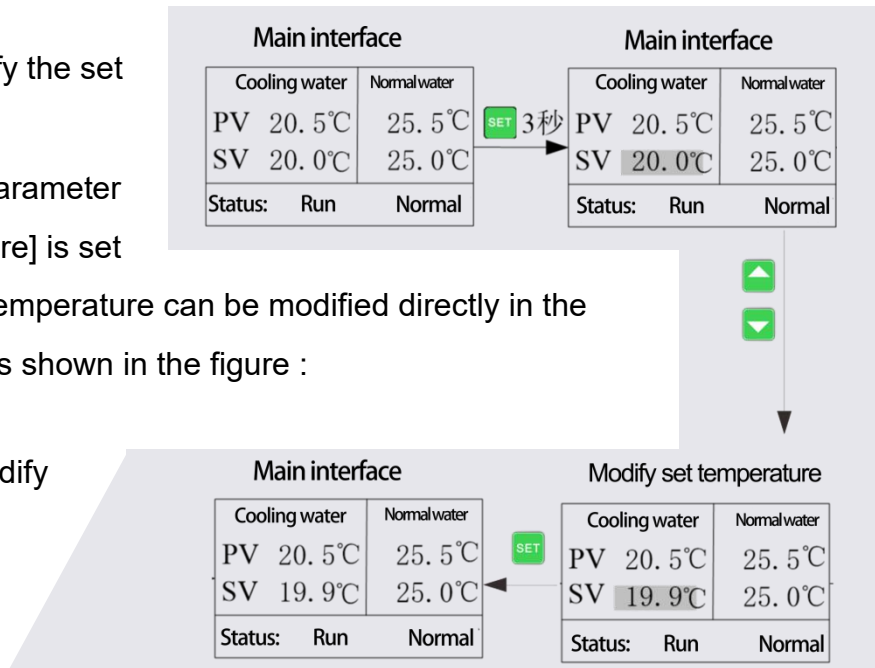



Figure 7-5 LCD screen controller parameter settings

Display in dark color when selected.

[Remark 2] : Dual temperature mode modification

Set temperature, press button to switch  Change to low temperature water/normal temperature Water set temperature.



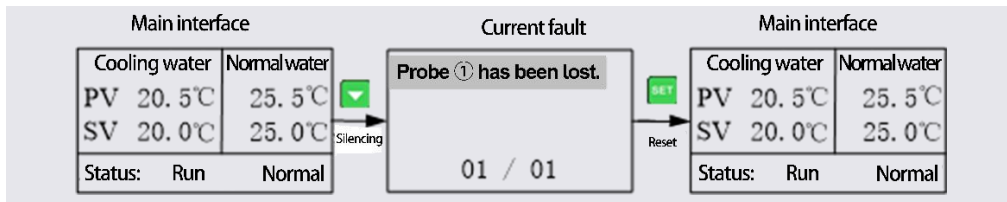

②. Query/reset fault

When a fault occurs, an alarm prompt appears on the main interface. The fault query and reset operations are as follows:



7.5.3 All-in-one controller parameter setting

① Setting Recipe

At the startup stage, long press  and  at the same time to enter the recipe selection window, the main display screen shows the current recipe version, Short press  or  to switch the specific formula, short press  to save, countdown 5s after the automatic start.

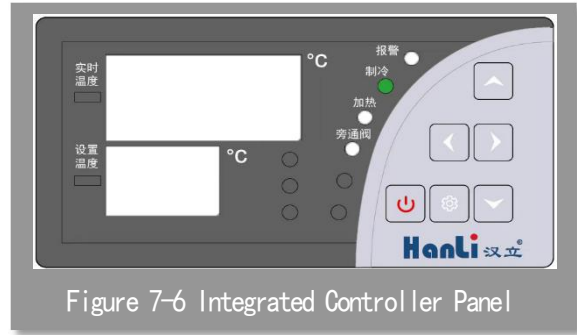







Figure 7-6 Integrated Controller Panel

② Set the cooling temperature

After startup, in non-setting state, long press  to enter the interface of setting refrigeration temperature, the sub-screen displays the currently set refrigeration temperature and flashes.

Short press/long press  to increase the value once/increase continuously; short press/long press  to decrease the value once/increase continuously. Short press "1" to save and exit setting state, short press  to not save and exit setting state.

③ Setting advanced parameters

After startup, non-setting state, long press   at the same time to enter the advanced settings window, the main screen displays "Function Options List", displaying The main screen displays "F-number", and the secondary screen displays the value of the corresponding "Function Options".

After entering the advanced setting window, short press/long press  to scroll to the left once/continuously to the function option list.

After entering the advanced setting window, short press/long press  to scroll to the right once/continuously to the list of function options.

After entering the Advanced Settings window, short press/long press  to increase the value of the current function option once/continuously.

After entering the advanced setting window, short press/long press  to scroll to the right once/continuously, the value of the current function option.

Short press  to save, short press  to exit setting status.

8 Maintenance

Note: Equipment maintenance must be stopped first , cut off the power supply , and wait for 3 minutes before proceeding , otherwise there is a risk of electric shock. When the ambient temperature is lower than 2°C and the machine is shut down for a long time, the internal water must be drained.

8.1 Dust protection in summer

In summer , please clean the equipment condenser and dust filter in about 7 days , as shown in Figure 8-1 .

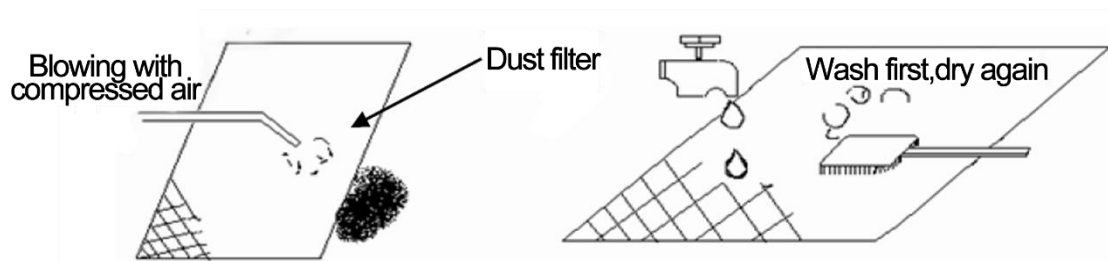
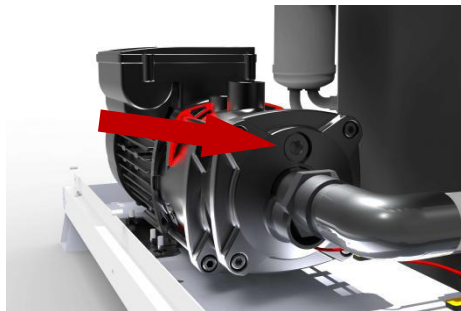

Figure 8-1 Dust filter cleaning and dust removal process

8.2 Antifreeze in winter

When the equipment is transported or not used for a long time , the water in the water tank should be drained through the drain valve , and at the same time, loosen the drain plug under the water pump to drain out the remaining water in the water pump , as shown in Figure 8-2 .

1. First open the drain valve and drain the water.



2. Unscrew the water pump exhaust screw

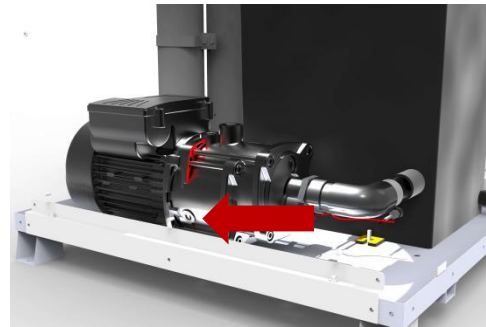

3. Remove the screws at the bottom of the water pump

Figure 8-2 Winter antifreeze maintenance

If the ambient temperature at night is lower than 2°C , It is recommended that customers do not stop the machine or add antifreeze . The volume ratio of ethylene glycol is selected according to Table 1. The freezing point to be prevented is equal to the ambient temperature of the equipment minus about 5°C. When the daily average temperature is higher than 5°C , replace the water containing antifreeze with purified water.

Table 1 Correspondence between different volume ratios of ethylene glycol and freezing point

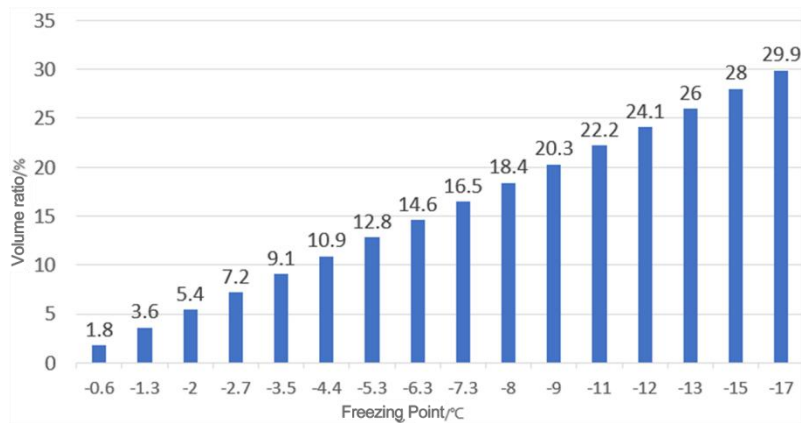

8.3 Daily maintenance

The working scene of the fiber laser chiller is very harsh . In order to ensure the good performance of the equipment and extend the service life of the equipment , the equipment needs to be maintained . The maintenance frequency is once a week . The maintenance work includes but is not limited to the following aspects: .

- Check the condenser , check whether the air duct is blocked by foreign matter , and whether the air inlet and outlet around the equipment is unobstructed;
- Clean the condenser and clean the dust filter;
- Check whether there are foreign objects in the refrigerant and whether microorganisms breed, etc. Generally , the refrigerant should be replaced every 30 days. The secondary refrigerant shall be purified water or ethylene glycol solution with a volume concentration not exceeding 30%;
- Check whether the water pipe joints are loose and whether the water pump is leaking;
- Check the water tank and clean the dirt deposited inside the water tank;
- Regularly clean the filter in the waterway of the equipment . Generally , the filter should be cleaned once every 7 to 10 days . The commonly used filters of our company are as shown in Figure 8-3. The Y-type filter is placed at the water suction port of the water pump or the water outlet of the equipment ;
- Test insulation resistance , insulation resistance $\geq 5\text{M}\Omega$;
- Check the ground resistance , ground resistance $\leq 1 \Omega$;
- Conduct a capacitance test on the capacitors of the compressor and fan . If the capacitance decay exceeds 10%, the capacitors need to be replaced.

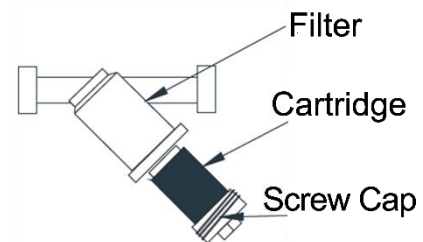

Y-type Filter

Figure 8-3 Filters commonly used in our company

8.4 Hazard tips for inadequate daily maintenance

- If the dust filter or condenser is not cleaned in time, the heat exchange efficiency will be reduced, the heat will accumulate, causing the fluorine pressure to rise or even the high pressure alarm, resulting in the chiller can not operate normally. Running under this condition for a long time will seriously affect the service life of the compressor.
- If the filter is not cleaned in time, the dirty blockage of the filter will reduce the water flow, cause the water temperature to rise, and even cause the laser to alarm at high temperature, which will not work normally.
- If non-pure water is added or the refrigerant is not replaced in time, it may lead to the blockage of the water channel, reduce the water flow, cause the flow alarm of the chiller or the high temperature alarm of the laser, and make the chiller unable to work normally. In severe cases, it may cause the plate heat exchanger to be completely blocked, affecting the cooling capacity of the chiller, resulting in the chiller not working normally. If antifreeze is not added in time in winter, it will cause damage to water pumps, lasers, etc.
- If the capacitor capacitance of the compressor or fan is attenuated by more than 10%, the compressor or fan will be damaged.

9 Fault analysis and troubleshooting

When the machine detects a fault , the display area alternately displays temperature and fault code "Exx". If there are multiple faults , you can press <Up> or <Down> to switch to view different faults . After pressing the <Up> or <Down> key, the fault code will be permanently displayed . After 5 seconds , the temperature and fault code will be displayed alternately again. The fault codes and descriptions are as follows:

Table 2 Split controller fault code table

Fault code	Fault name	Failure analysis	Fault phenomenon	Method of exclusion
E01	low temperature water Probe failure	A : Low temperature water probe short circuit/disconnection B: The low temperature water probe is damaged	If the water pump does not stop, all other outputs will stop.	A : Check whether the probe wire is loose B: Replace the probe
E02	low temperature water High temperature alarm	A : Insufficient water flow B: Poor ventilation C : Too much dust	Only low-temperature hydroelectric heating is stopped	A: Test the water supply pipeline B: Clean up the surrounding debris C : Clean the dust on the condenser
E03	Low voltage alarm	A : The throttle tube is blocked B : Refrigerant leakage C : The pressure switch is damaged	Stop the compressor but not the water pump	A : Tap the throttle tube lightly B : Check for leaks C : Check whether the pressure switch and wiring are loose or short-circuited
E04	Phase sequence alarm	A: Power supply phase loss/phase loss B: Phase sequence error C: Three-phase unbalanced B: The phase sequence protector is damaged	Stop the whole machine	A: Check the power supply circuit B: Swap two phase lines at will C: Check the power supply circuit D: Replace the phase sequence protector
E05	low temperature water Traffic alarm	A: The low-temperature water pipeline is blocked or broken. B: The water inlet and outlet are connected reversely C: The water suction pipe is leaking D: The flow switch is damaged	If the water pump does not stop, all other outputs will stop.	A : Clean and check the pipeline B: Check the inlet and outlet pipes C: Check the water suction pipe and tighten it D: Check the flow switch and replace it
E06	Water pump current Overload alarm	A : The water pump is stuck B: Blocked by impurities C: Water pump phase loss/phase loss D: The voltage is too low	Stop water pump	A: Check whether the water pump is running B: Is the tail fan rotating? C: Check the water pump power supply D: Check the water pump voltage

Fault code	Fault name	Failure analysis	Fault phenomenon	Method of exclusion
E07	High voltage alarm	A : The condenser is dirty and clogged B : The air inlet and outlet are blocked C : The ambient temperature is too high D : The fan does not rotate E : Plate replacement for dirty plugs F : Throttle tube blocked G : The pressure switch is damaged	Stop the compressor but not the water pump	A : Clean the dust B : Clean the debris around the equipment C : The equipment is placed with good ventilation D : Check whether the fan is rotating E : Plate replacement and cleaning F : tap the throttle tube G : Check whether the pressure switch and wiring are loose or short-circuited
E08	low temperature water Low temperature alarm	A: The outlet water temperature of the equipment is too low	Stop the compressor but not the water pump	A: Check whether the relay is stuck
E09	normal temperature water Probe failure	A: The normal temperature water probe is short-circuited/disconnected B: The normal temperature water probe is damaged	If the water pump does not stop, all other outputs will stop.	A : Detection probe terminals and connections B: Replace the probe
E10	normal temperature water High temperature alarm	A : Insufficient water flow B: Poor ventilation	Only normal temperature water and electric heating will be stopped	A: Check whether there is return water at room temperature and whether the waterway is blocked. B: Clean up the surrounding debris
E11	normal temperature water Low temperature alarm	A : The outlet water temperature of the equipment is too low	Stop the compressor but not the water pump	A : Check whether the relay is stuck
E12	normal temperature water flow alarm	A : The normal temperature water pipe is blocked B: The water inlet and outlet are connected reversely C: Water leakage from normal temperature water pipe D: The flow switch is damaged	Stop normal temperature water and electric heating	A : Check whether there is water return to the cutting head B: Check the inlet and outlet pipes C: Check the water pipe joints and tighten them D: Replace the flow switch

[Remarks]: For faults that require manual reset , the split controller button  resets the fault and starts automatically after the fault is eliminated.

Note : The alarm information in the above table is for reference only and is subject to change without prior notice.

table 3 LCD controller fault name table

Fault name	Detection conditions	Fault phenomenon	reset mode
Pressure switch alarm	Detection after press operation [pressure switch alarm delay] time	Stop all compressors but not the water pump	automatic
Compressor failure	Compressor inspection after operation		Manual
Press current is too low			Manual
Water pump overload	Inspection after operation of water pump	Stop the whole machine	Manual
Water pump current is too low			Manual
Probe ① low temperature alarm	Power-on detection	Stop all compressors but not the water pump	automatic
Probe ① high temperature alarm		Alarm, power outage and heating①	automatic
Probe ② low temperature alarm		Stop normal temperature water valve, non-stop water pump	automatic
Probe ② high temperature alarm		Alarm, power outage and heating②	automatic
Temperature control probe ① disconnected	Power-on detection	The water pump does not stop and all other outputs stop.	Manual
Temperature control probe ① short circuit			Manual
Temperature control probe ② disconnected	Power-on detection	The water pump does not stop and all other outputs stop.	Manual
Temperature control probe ② short circuit			Manual
Environmental probe disconnected	Power-on detection	The water pump does not stop and all other outputs stop.	Manual
Environmental probe short circuit			Manual
Water flow switch ① alarm	Inspection after operation of water pump Antifreeze mode: The water pump runs and detects after the delay [antifreeze flow detection delay] time	Alarm, power outage and heating ①, stop all compressors and fans	automatic
Water flow switch ② alarm		Alarm, power outage and heating②	automatic
Phase sequence alarm	Power-on detection	Stop the whole machine	Manual
Normal temperature electric heating over-temperature alarm	After the machine is powered on, it starts to detect , and after the [Temperature ② Alarm Delay] debounce time	Alarm, power outage and heating② The alarm output point is temperature ② alarm output	automatic
Unit needs maintenance	Inspection after operation of water pump	Once the unit is shut down, it cannot be started (the cumulative running time of the unit exceeds [trial time])	
Please perform equipment maintenance ①	Detected once when powering on	It only alarms and does not affect the operation of the equipment. If the alarm goes off for more than 20 minutes without manual reset operation, it will automatically reset, and the alarm will still appear next time when power is turned on; If the fault is manually reset within 20 minutes of the alarm, the maintenance timer will be cleared	
Please perform equipment maintenance②			
Please perform			

equipment maintenance ③		and the alarm will no longer occur next time the power is turned on.	
Anti-icing probe disconnected	Power-on detection	The water pump does not stop and all other outputs stop.	Manual
Anti-icing probe short circuit			Manual
Anti-icing temperature is too low	Power-on detection	Stop all compressors and non-stop water pumps	automatic

10 Circuit diagram

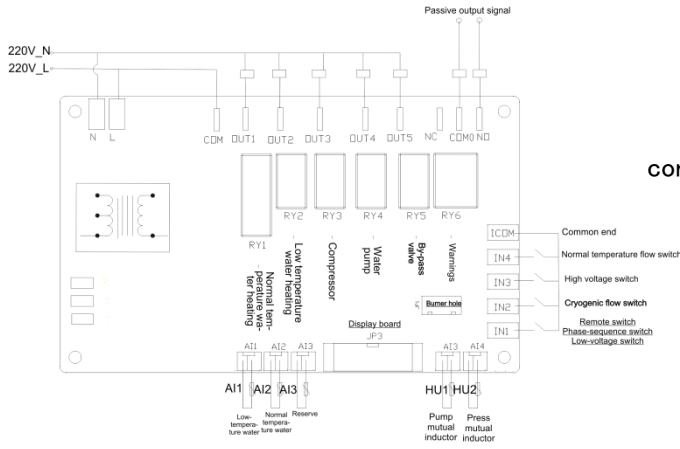
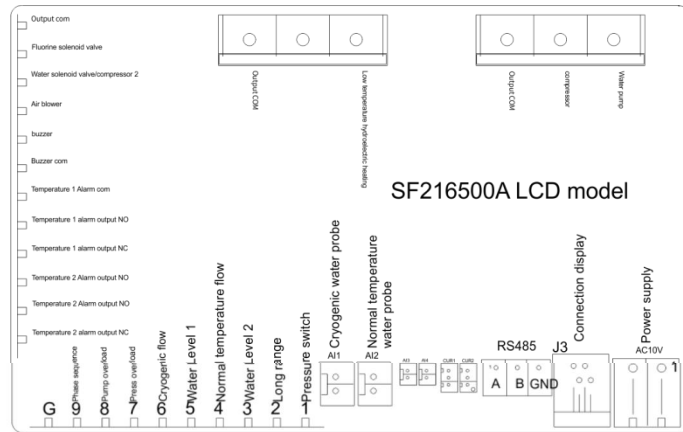

Figure 10-1 Separate controller of 380V device Circuit diagram

Figure 10-2 380V LCD controller Circuit diagram



SF216500A LCD model

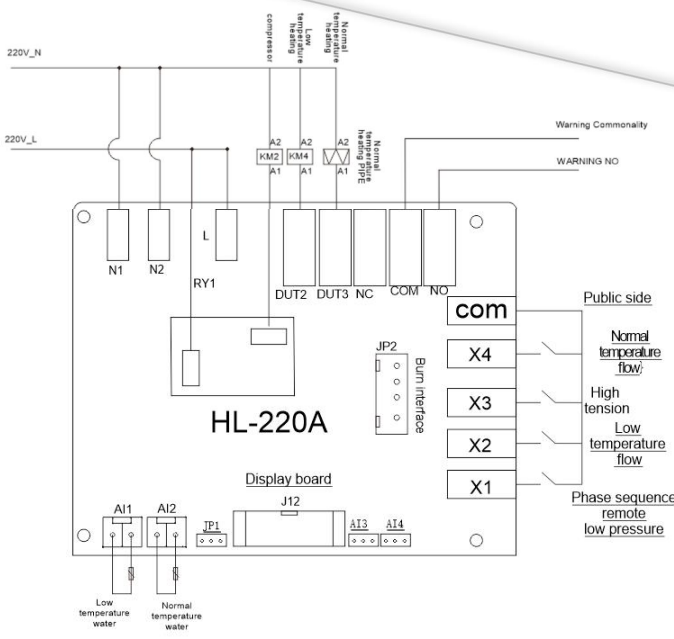

Figure 10-3 220V split controller Circuit diagram

11 Transportation and storage

11.1 Transportation requirements

1. When transporting or handling , please do not bump up and down or tilt excessively (no more than 45°) , and avoid collision, impact and flipping.
2. When moving the equipment , please use the correct tools , such as forklifts or overhead cranes , and do not carry the equipment with bare hands .
3. Before moving the equipment , please remove the power cord and drain the cooling machine inside the system . Do not move or transport the equipment with liquid.
4. When using a forklift to move the equipment , make sure the equipment is in a stable state and the height is less than 200mm from the ground , and make sure to avoid the casters of the equipment.
6. When using a crane to move the equipment , the equipment needs to be held stably by a wire rope before it can be moved.

11.2 Storage requirements

When out of use for a long time , please drain the cooling machine in the equipment , and use compressed air to drain the water pump, normal temperature heating tank, filter, and remaining cooling machine in the pipelines . Wipe off the water and oil stains , and use a stretch film to clean them. Pack the equipment to prevent dust and water , and place it in a cool and ventilated place without direct sunlight or dust accumulation . If there are equipment with casters , lock the universal wheels.

Storage environment conditions : Temperature: 0~60℃ ; Relative humidity: ≤90%.

12 Other instructions

12.1 Service support

12.1.1 Warranty scope

- Within 24 months from the date of purchase of the product from the company , if the failure is obviously caused by a design defect or a quality problem caused by manufacturing , the company will provide free repairs and replacement parts.
- After the warranty period expires , lifetime paid maintenance will be provided.

12.1.2 Situations not covered by warranty

- Damage caused by failure to install , use and maintain the product in accordance with the instructions, or when external conditions such as power supply do not meet the requirements during use.
- Damage not caused by improper transportation and storage by our company.
- The company's products have been modified or damaged due to other human factors.
- Damage caused by force majeure. Such as: natural disasters , wars, etc.
- Damage caused by installation on vehicles, ships or use abroad.
- Damage due to equipment failure.

12.2 Other matters

- The power supply must be installed in accordance with national wiring standards and specifications (voltage , frequency , and voltage difference must all meet the requirements).
- If the power cord is damaged , it must be replaced by the manufacturer's maintenance department or professionals from similar departments to avoid danger .
- During maintenance, the power must be turned off for 3 minutes before maintenance can be performed.